

boso TM-2450

smaller  
lighter  
quieter

BOSCH  
+SOHN

boso



# 24h Blood Pressure Monitor boso TM-2450





# 24h Blood Pressure Monitor boso TM-2450



New packaging concept

Sustainable and clearly arranged





# 24h Blood Pressure Monitor boso TM-2450



## Cuffs

New sizes. New design.

Can be washed off and is latex-free.

S | M | M-right | L | XL



## Cuffs

Size M	CA91	20 - 31 cm	259-4-400
Size M-right	CA91R	20 - 31 cm	259-4-440
Size L	CA92	28 - 38 cm	259-4-410
Size XL	CA94	36 - 50 cm	259-4-430
Size S	CA93	15 - 22 cm	259-4-420

## Protective covers (10 pieces)

Size M left and right	259-7-400
Size L	259-7-410
Size XL	259-7-430
Size S	259-7-420
Size M and Size L (each 5 pieces)	259-7-405



## Varta Premium Batteries

2100 mAh / 600 measures

The VARTA Recharge Recycled Batteries are made from 11% recycled material and combine the benefits of low self-discharge with environmental friendliness.



## Varta Premium Charger

Safety switch-off  
4 charging slots

# 24h Blood Pressure Monitor boso TM-2450

## Scope of delivery



24-hr blood pressure monitor  
boso TM-2450



Transport case

Battery charger

2 x battery packs with two batteries  
(one set already inserted into the device)



Cuffs for adults (can be washed off, latex-free)

- Size M (13 x 62 | 20 – 31)
- Size L (16 x 68 | 28 – 38)
- Cuffs, optional: S (10 x 38 | 15 – 22), XL (17 x 76 | 36 – 50)



Hip bag with removeable strap and belt

Instruction manual for:

- boso TM-2450
- profil-manager XD
- Important notes
- Battery charger

CD-ROM – boso profil-manager XD

USB connection cable

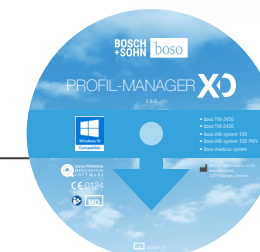



## High-performance and effective

- Measures during pumping and drain process
- Arrhythmia detection
- Activity sensor
- Quick and easy programming
- Freely programmable intervals
- Sleep button
- Storage of 600 measurements
- Great wearing comfort thanks to the small and lightweight design with only 2 batteries
- Extremely low noise level
- Ergonomic hip-bag including transport strap and belt



20.5% smaller

22,5% lighter

33% quieter

# 24h Blood Pressure Monitor boso TM-2450



## Overview

Device	TM-2430 PC 2	TM-2450
Dimensions	72x27x100 mm	66x25x95 mm
Weight	155 g	135 g
Adapter socket	Jack	micro-USB
Measurement storage	350	600
Connection cable	Jack to USB	Micro-USB to USB
Battery	3 pieces	2 pieces
Battery charger	4 batteries	4 batteries
Cuff sizes	S I M I L	S I M I L   XL
Compatible cuffs	no	no
Air connection plugs	identical	identical
Transport case	Plastic	Cardboard
Pump volume	loud	very quiet
Measuring function	drain	pump /drain
Temperature sensor	no	yes
Air pressure	no	yes
Arrhythmia detection	no	yes
Activity sensor	no	yes
Pressure curve	no	yes
On/off switch	yes	no
Reset button	yes	no

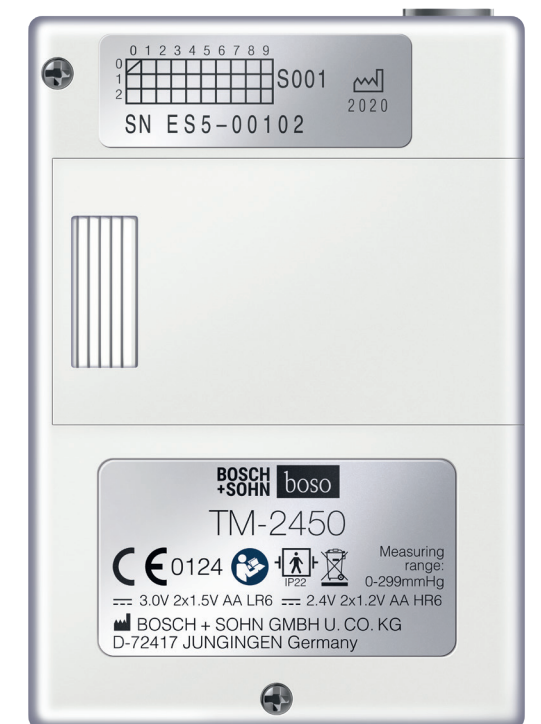



## Device overview

Cuff connection socket

AUTO button (day/night button)

START/STOP button

Battery compartment

2LR6 (AA) batteries

Micro USB connection

Batterie compartment lid

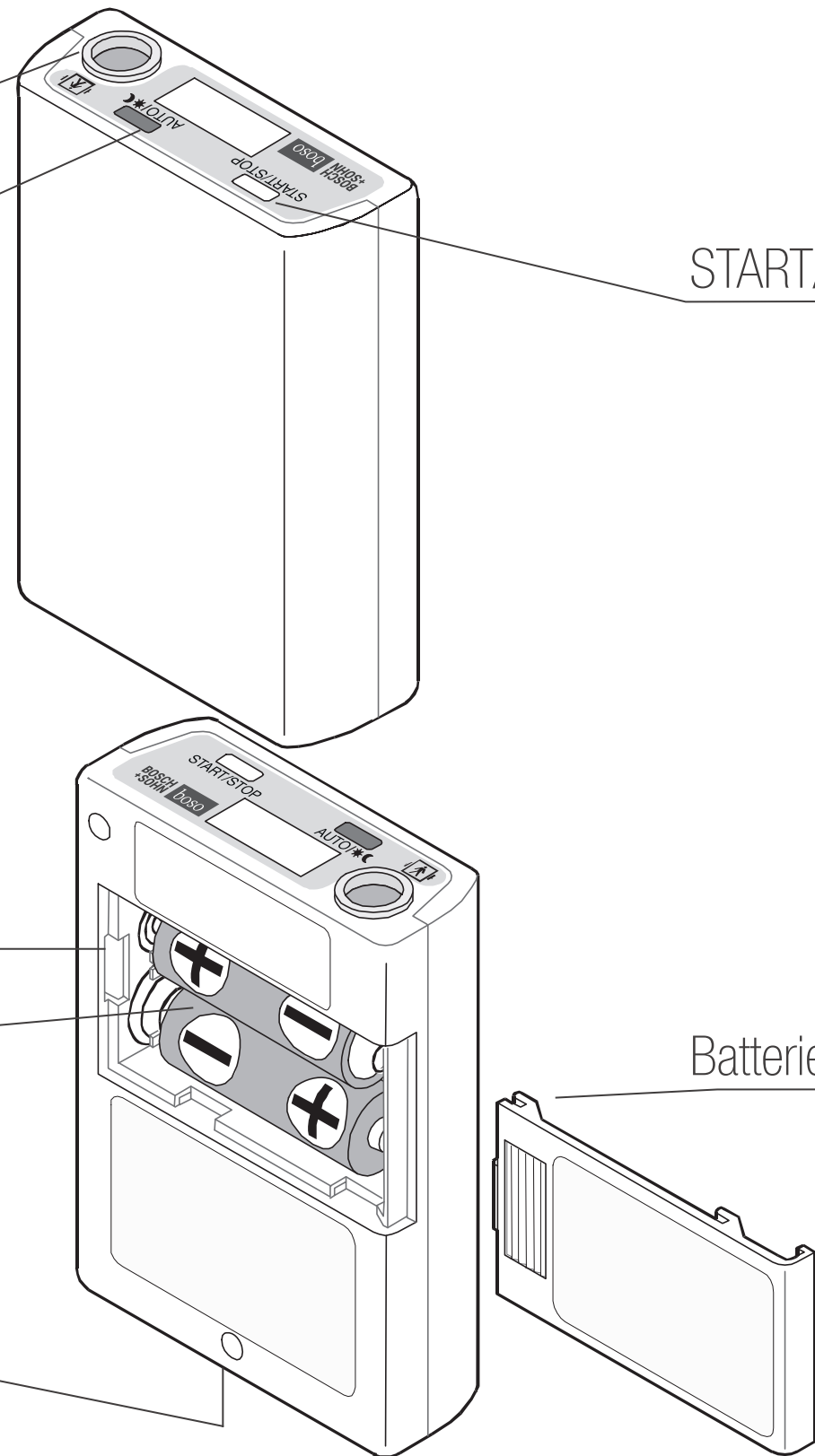

## Function symbols on the measuring device



START/STOP button



AUTO button (day/night button)



Automatic mode active



Sleep mode active



1. Battery charged



2. Battery partially charged



3. Battery empty (no further measurement or data transfer possible)



Storage full – 600 measures (no further measurements possible)





## Attaching the cuffs

Place the cuff on the unclothed upper arm so that the white marking lies on the arteria brachialis.

The cuff should lie roughly 2-3 cm above the elbow bend and should not be too tight. Two fingers should fit between the arm and cuff.

Maximum one finger between the arm and XL cuff.

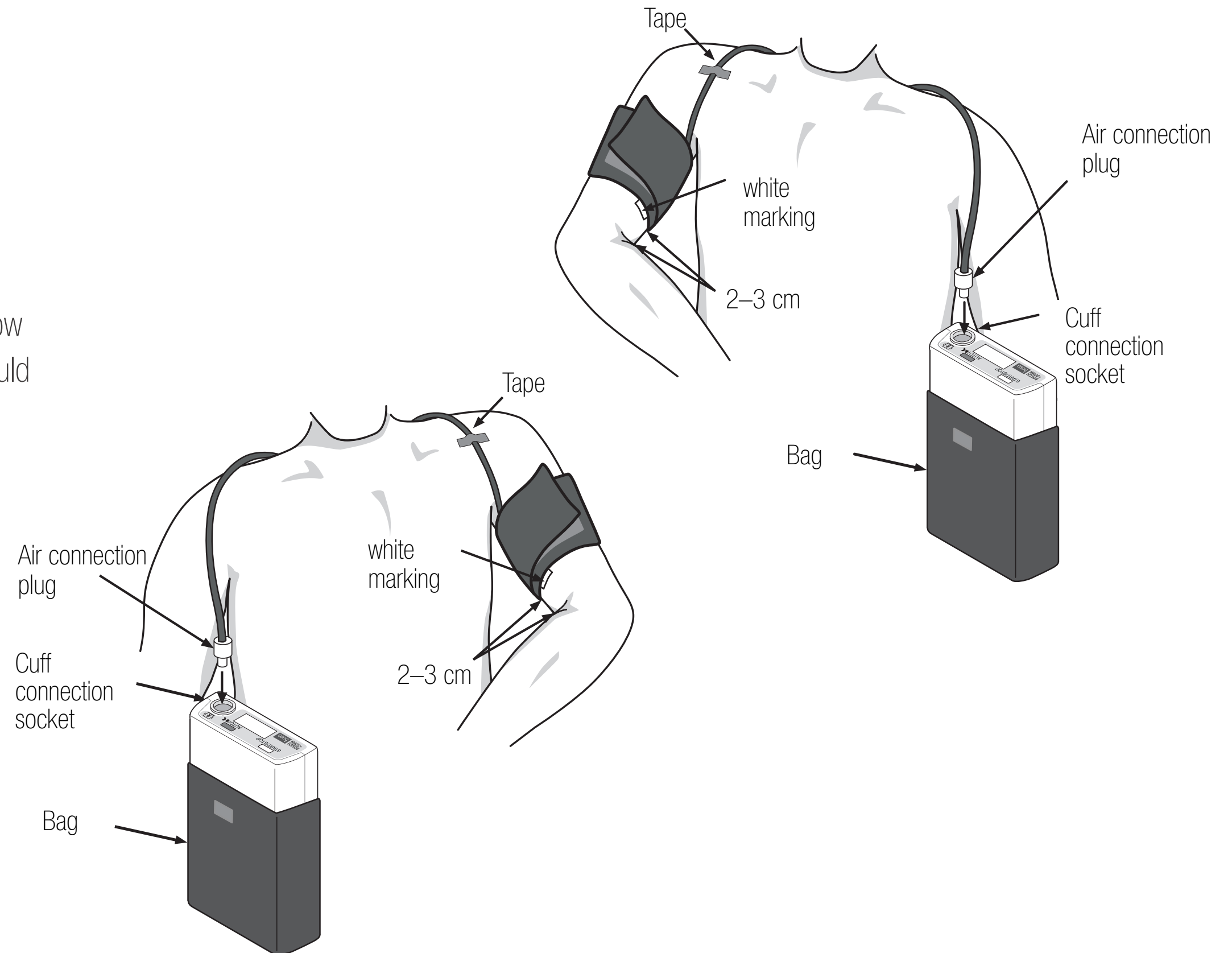

## Start of the interval automation

To start the automatic interval function, press and hold the black AUTO button with the display activated until "⌚" appears in the blood pressure monitor display and is confirmed with a short signal tone (after approx. 5 seconds).

If the display is off, activate it by pressing any button.

If the device is operated in "Sleep button" mode, the patient must press the black AUTO button before going to sleep. Next to the "⌚" for the automatic system, a "☾" appears in the display. After getting up, the black AUTO button must be pressed again.

The "☾" symbol disappears in the display.





## Performing a measurement

Automatic adjustment of the pumping level (only in automatic interval mode)

The boso TM-2450 automatically pumps up to the required pressure level.

If this pumping level is not sufficient, the device automatically pumps approx. 60 mmHG above the original pumping level.

Limiting the maximum pumping level

The boso TM-2450 has the option to limit the pumping level.

For the corresponding procedure, please refer to the boso profil-manager XD instruction manual.

Performing a manual measurement

In addition to the automatic measurements, the patient can start a manual measurement at any time. This can be sensefull after situations with physical or emotional stress for example. To do so, simply press the white START/STOP button.



## Cancellation of the measurement



To cancel the measurement, the white START/STOP button must be pressed on the boso TM-2450.

If the measurement is to be taken at a later time a manual measurement can be taken using the START/STOP button at any time.





## Ending the measurement and transferring the measured data

As soon as the device is removed from the patient after the 24-hour measurement has been completed, the automatic function must be switched off. To do so, press and hold the black AUTO-button while the display is activated until the '⌚' symbol disappears in the blood pressure monitor's display (approx. 5 seconds). If the display is off, activate it by pressing any button.

After that, connect the TM-2450 to a computer with a PC-connection cable. Transfer the data according to the boso profil-manager XD instruction manual.

After transferring the measured data, it is highly suggested to delete the data memory.



## Replacing the batteries

We recommend that after each 24-hour measurement, the used battery set is changed and replaced using a newly charged battery set.

To prevent any data loss, the data stored on the boso TM-2450 are buffered using an internal battery. These batteries are automatically charged via the battery pack. With a fully charged battery pack, the data remain stored for approx. 10 days.

To fully charge the battery for the first start-up, switch on the device with a fully charged battery pack for 24 hours.

Step 3

Insert charged batteries in the battery compartment

Step 2

Remove empty batteries

Step 1

Press the battery compartment lid down firmly and then slide it outwards.

Step 5

Close batterie compartment lid

Step 4

Note the polarity

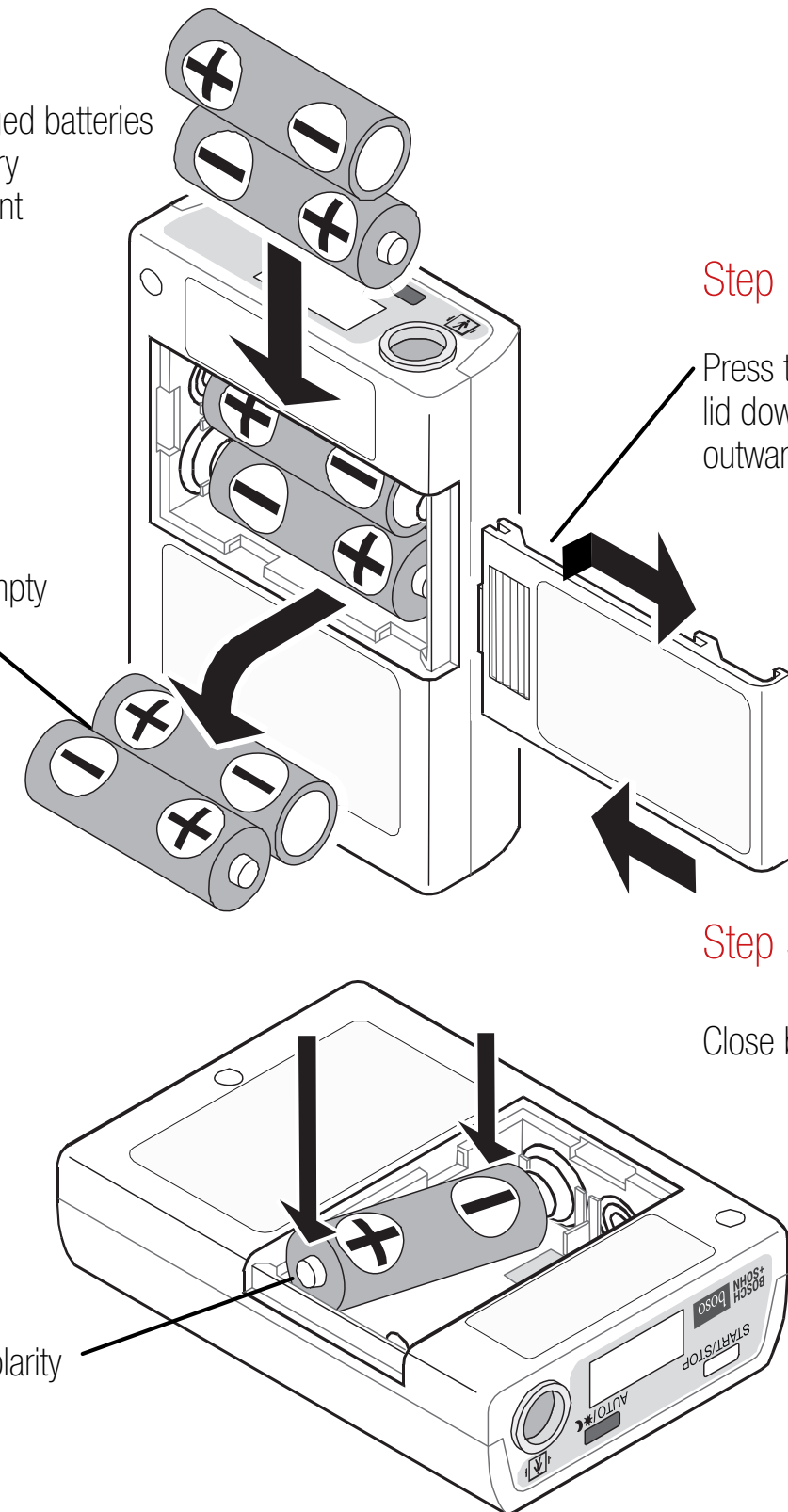



## Charging the batteries

Insert the rechargeable batteries into the charger and plug it into the power socket. If the blue LED lights up, the battery packs are being charged. The charging process takes roughly 11 hours for a fully charged battery pack.





On average, a charge of approx. 10 hours suffice following a 24-h measurement (cf. charger's instruction manual).



## Longer storage of the device

If the device is not used for a longer period of time (4 weeks or more), remove the batteries to prevent possible damage due to leakage.

Before the device is then attached to a patient again, the internal battery must be charged and the device reprogrammed.

-  Insert freshly charged batteries.
-  Please leave the battery packs in the device for two hours. The internal battery is recharged during this time.
-  Reprogram the device.
-  Before attaching the device to a patient, replace the batteries with a set of freshly charged ones.

## Important note

To ensure proper functioning of the boso TM-2450 over 24 hours, only use rechargeable batteries rated at least 1900 mAh, 1.2 V NiMH. In addition to the two rechargeable batteries required for the power supply, the boso TM-2450 also contains an internal battery to save the measurement data and the program settings in the device.



To prevent any loss of programming and stored measured values when the internal battery is discharged, please follow the following procedure:

- Insert charged batteries into the device even when not in use.

- The state of charge of the internal battery is thus constantly kept at a high level. If the internal battery's power supply is interrupted, the settings of the boso TM-2450 will be lost after approx. 10 days.
- Before attaching the device to a patient, please replace the batteries in the device with a set of freshly charged batteries.



## Error codes

Error code	Cause	Remedy
0:00	Time sets to 0:00 when battery is replaced	Device must be reprogrammed.
E03 / E90	Zero point adjustment not possible	Deflate cuff completely.
E04	Empty battery	Charge or replace batteries.
E05	Leakage	Disconnect the cuff from the device and reconnect. If the error occurs repeatedly, contact your sales partner.
E06	Pressure above 299 mmHg	The arm must be kept still during measurement.
E07	User abort via START/STOP button	
E08 / E10	No or non-interpretable oscillations	The arm must be kept still during measurement.
E09	Error of the activity sensor	Remove and re-insert the battery packs.
E20	Pulse < 30 or > 200	Check the position and fit of the cuff.
E21	No interpretable oscillations	
E22	In the area of diastole (E21) or systole (E22)	Check the position and fit of the cuff.
E23	Systole-diastole < 10 / > 150 mmHg	Check the position and fit of the cuff.
E30	Measuring time longer than 180 seconds	Contact your sales partner.
E31	Deflation longer than 90 seconds	Contact your sales partner.
E48	Pulse cannot be measured	The arm must be kept still during measurement.
E52	Storage error	Contact your sales partner.
E91	Pressure inside the cuff too high / maximum pressure set too low	Set a higher maximum pressure. The arm must be kept still during the measurement.



## Cleaning and disinfection

To clean the boso TM-2450 and the cuff, please use a soft cloth that may be moistened with soapy water. For the protective covers: machine wash at max. 60 °C.

Never use solvents, benzine, spirits or abrasive cleaners for cleaning!

For disinfection by wiping (exposure time at least 5 minutes) the device, we recommend the disinfectant Antifect Liquid (Schülke & Mayr). We recommend using spray disinfection for disinfecting the cuff. Especially if the device is used by multiple patients, make sure that the cuff is cleaned and disinfected regularly.

The boso TM-2450 and the boso profil-manager XD software meet the practical ABPM guidelines of the European Society of Hypertension in the following points:



boso TM-2450 (measuring device)

Clinically validated according to DIN EN ISO 81060-2 – precise blood pressure measurement on the upper arm

Major improvements of the new generation of devices:

- Cardiac arrhythmia display to indicate atrial fibrillation, for example
- Smart automatic inflation for a measurement without re-pumping
- Detection and recording of artefacts
- Capture of active and resting phases
- Detection of ambient temperature and atmospheric pressure-factors influencing blood pressure behaviour
- Extremely low pumping noise level for a significant reduction of impairment in the sleeping phase



The boso TM-2450 and the boso profil-manager XD software meet the practical ABPM guidelines of the European Society of Hypertension in the following points:



## boso profil-manager XD (ABPM-Software)

- Essential clinical report (one page)
- Standardised display of all blood pressure measurements with day and night display and delimited target pressure ranges
- Display of average systolic and diastolic blood pressure and heart rate
- Nighttime blood pressure drop (%) for systolic and diastolic blood pressure
- Summarizing statistics for time-weighted average systolic and diastolic blood pressure and heart rate for a 24-hour period, daytime (awake) and nighttime (sleeping), with standard deviations and number of valid blood pressure readings
- Option to display incorrect measurements (artefacts)

### Meets optional requirements:

- Option to display heart rate and mean blood pressure
- Comparison of repeated ABPM recordings
- Option to centrally host data

## Start screen

New design

New logo



Patient  
overview





## Measured data

Device can be initialised using the unique patient number (simple workflow for devices operated in parallel, e.g. in a hospital)

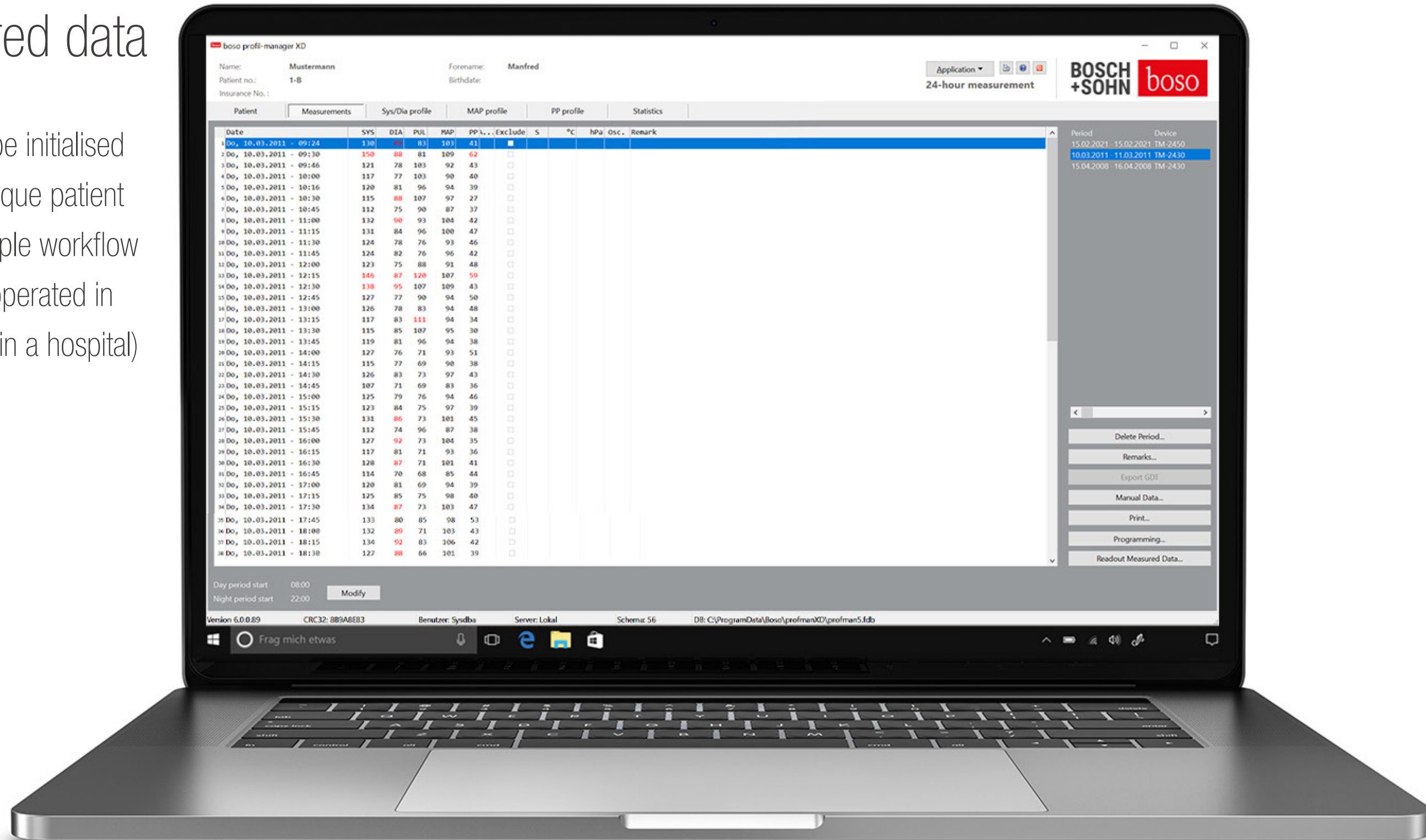

## Profile Sys/Dia

Overlay of two curves  
(SYS, DIA, PULS, MAP,  
PP) possible  
(easy identification of  
successful treatment),  
still compatible  
with boso TM-2430 PC2

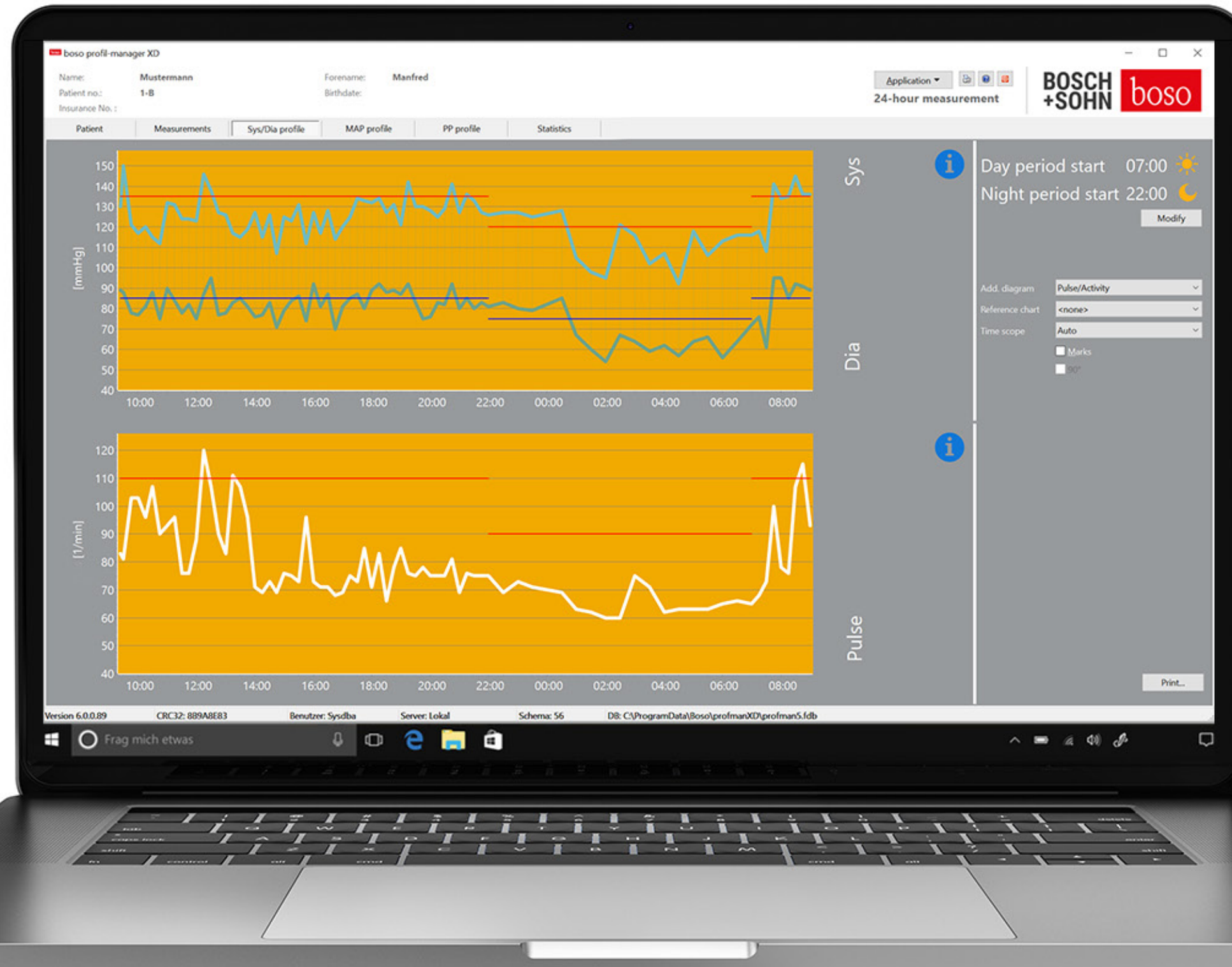

# Statistics

Statistical evaluation incl.  
calculation of the morning  
blood pressure rise  
(MBPS)

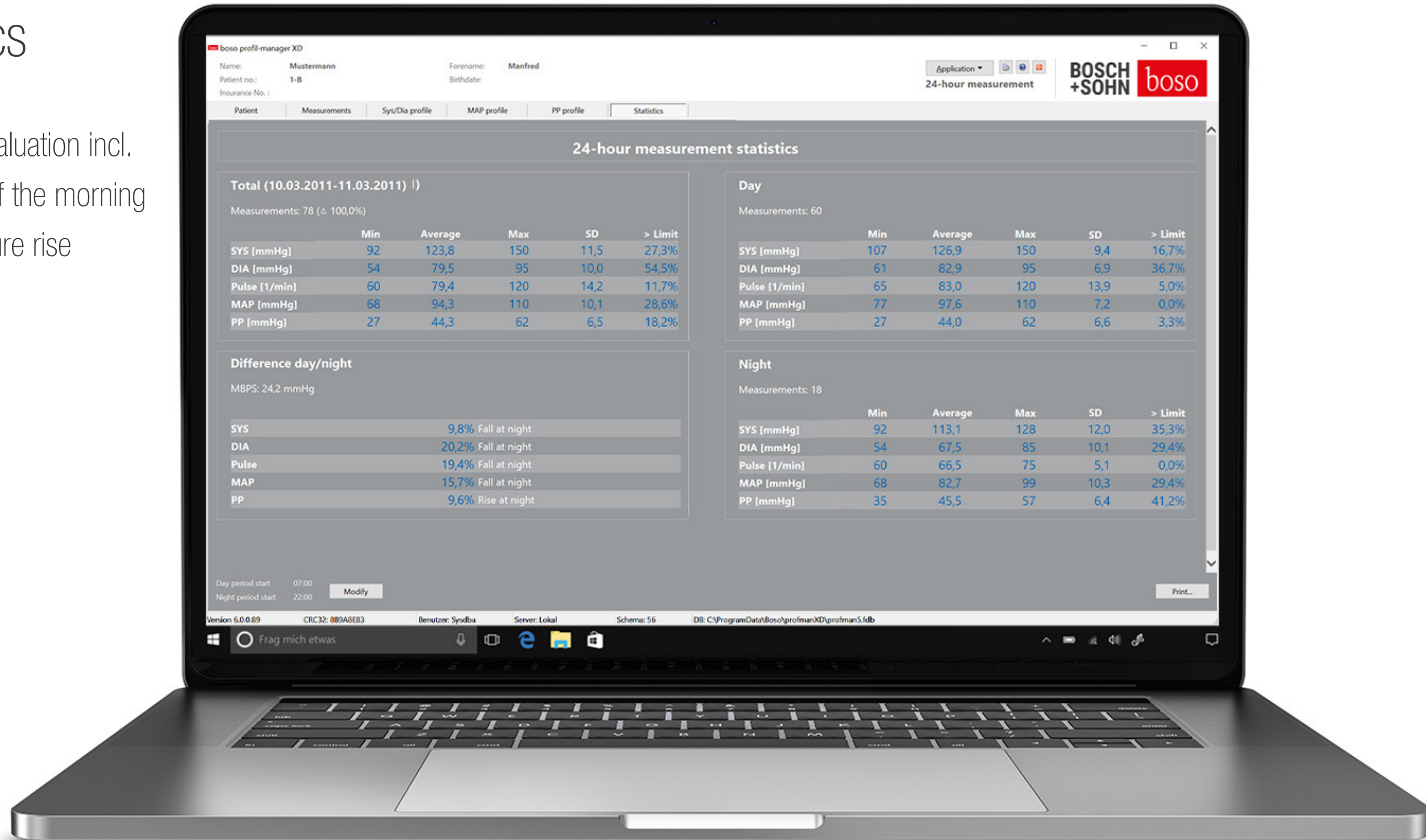



Easy mixed operation of  
boso TM-2430 PC2  
and boso TM-2450  
possible.

The interface settings were  
adapted accordingly for this:

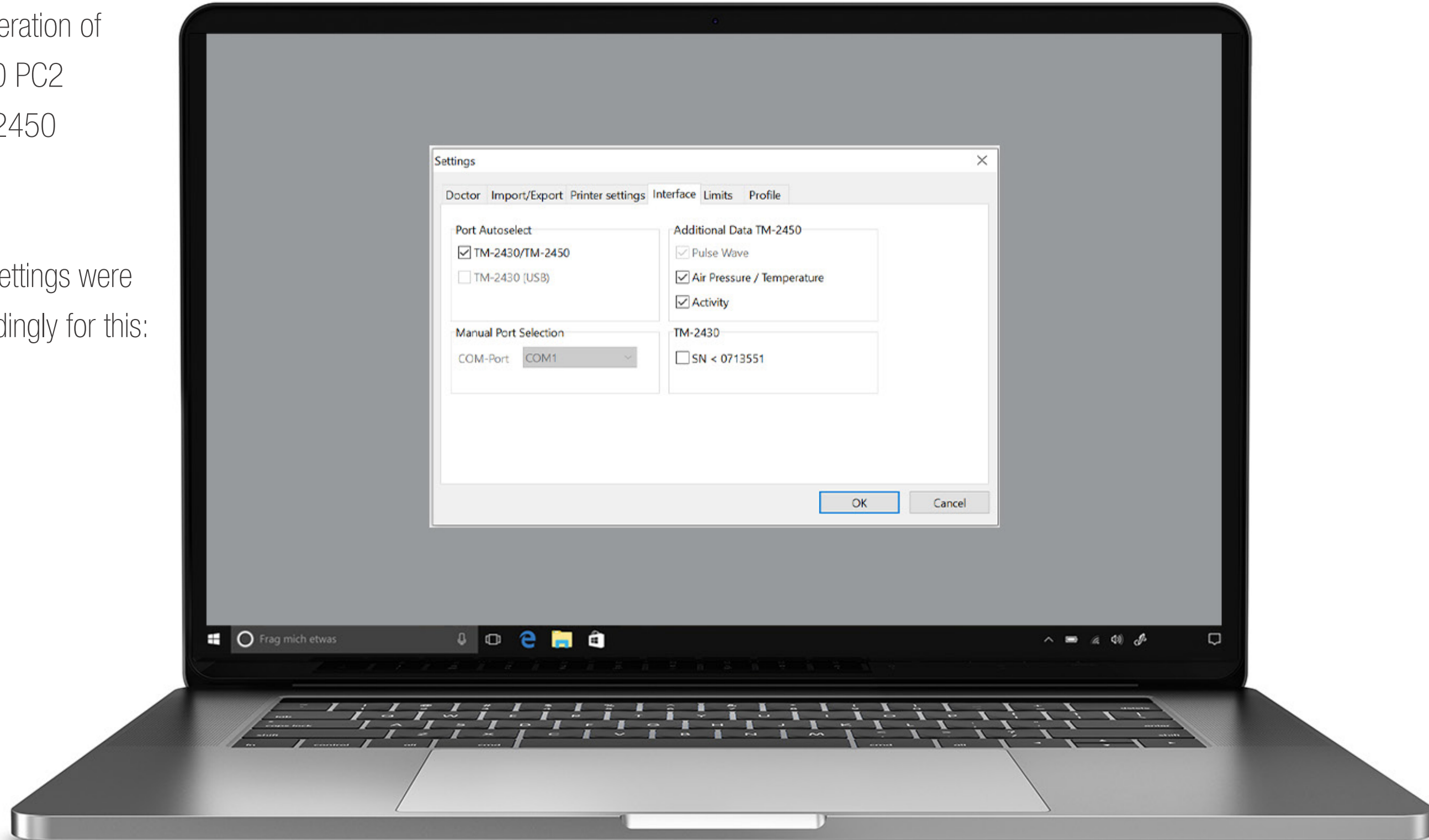

Definable maximum  
pressure (specifically for  
sensitive patients)

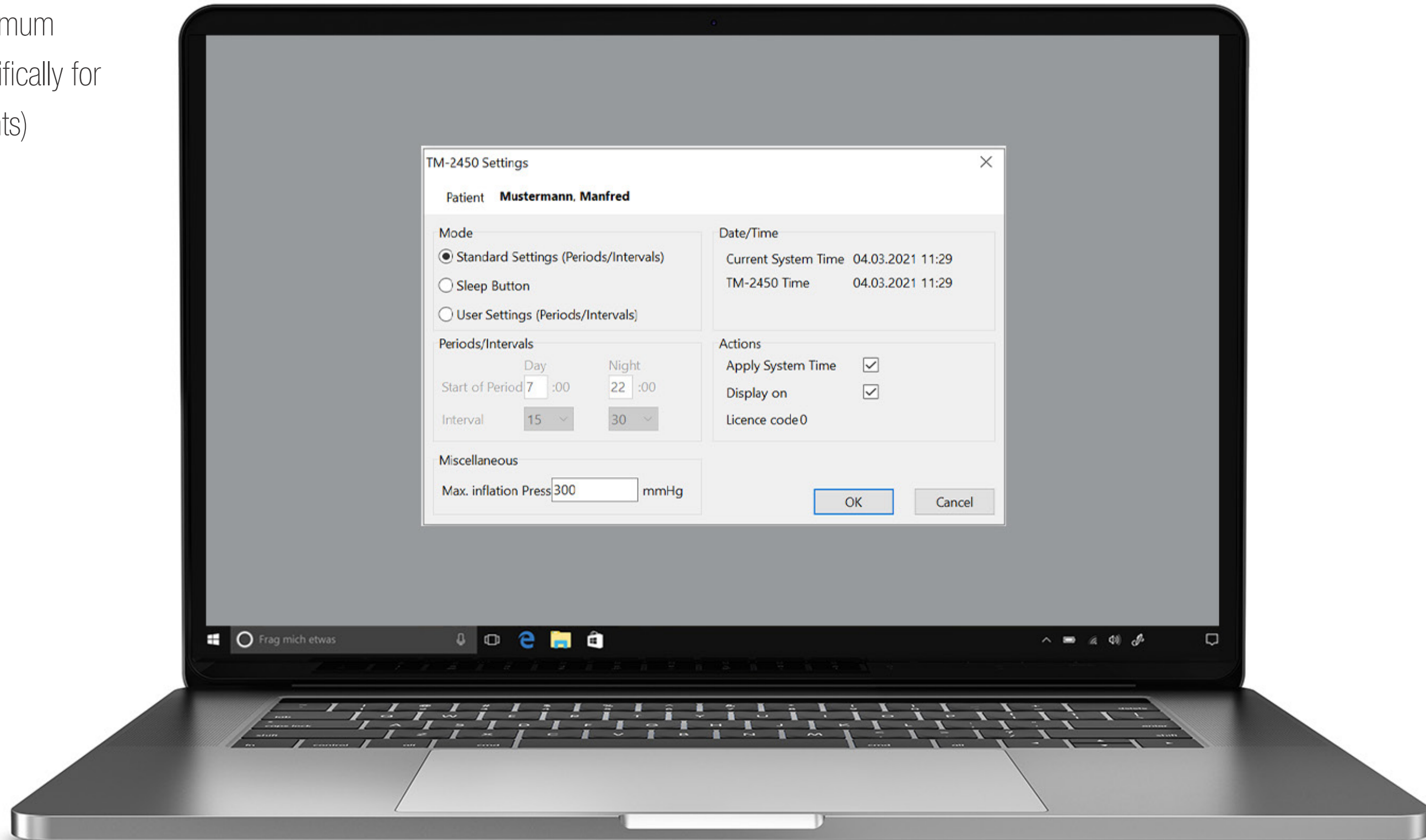

Measured data





## Atmospheric pressure

Recent studies demonstrate an influence of meteorological factors, such as atmospheric pressure, on blood pressure behaviour.

Source: Stergiou GS, Myrsilidi A, Kollias A, Destounis A, Roussias L, Kalogeropoulos P. Seasonal variation in meteorological parameters and office, ambulatory and home blood pressure: predicting factors and clinical implications. *Hypertens Res.* 2015; 7:869–875.

## Temperature

The relationship between blood pressure and outdoor temperature in a large study of older people - the Three Cities Study.

The study included nearly 9,000 patients aged 65 and older. Measurements were taken at different times of the year at different temperatures. The results showed that in winter the systolic value was about 5 mmHg higher than in the summer months on average. Thus, this demonstrated that in winter 1/3 and in summer only 1/4 of the measured persons should have been classified as hypertensives (patients with high blood pressure).

In people over 80 years of age, the effect of blood pressure variability may be increased in different weather conditions and outdoor temperature.

Source: Alperovitch A, Lacombe JM, Hanon O, Dartigues JF, Ritchie K, Ducimetière P, Tzourio C. Relationship between blood pressure and outdoor temperature in a large sample of elderly individuals: the Three-City study. *Arch Intern Med.* 2009; 169:75–80.

**BOSCH  
+ SOHN**



**boso**

BOSCH + SOHN GmbH u. Co. KG

Bahnhofstraße 64 | 72417 Jungingen, Germany | T +49 (0) 7477 9275-0 | F +49 (0) 7477 1021

E [zentrale@boso.de](mailto:zentrale@boso.de) | [boso.de](http://boso.de)